

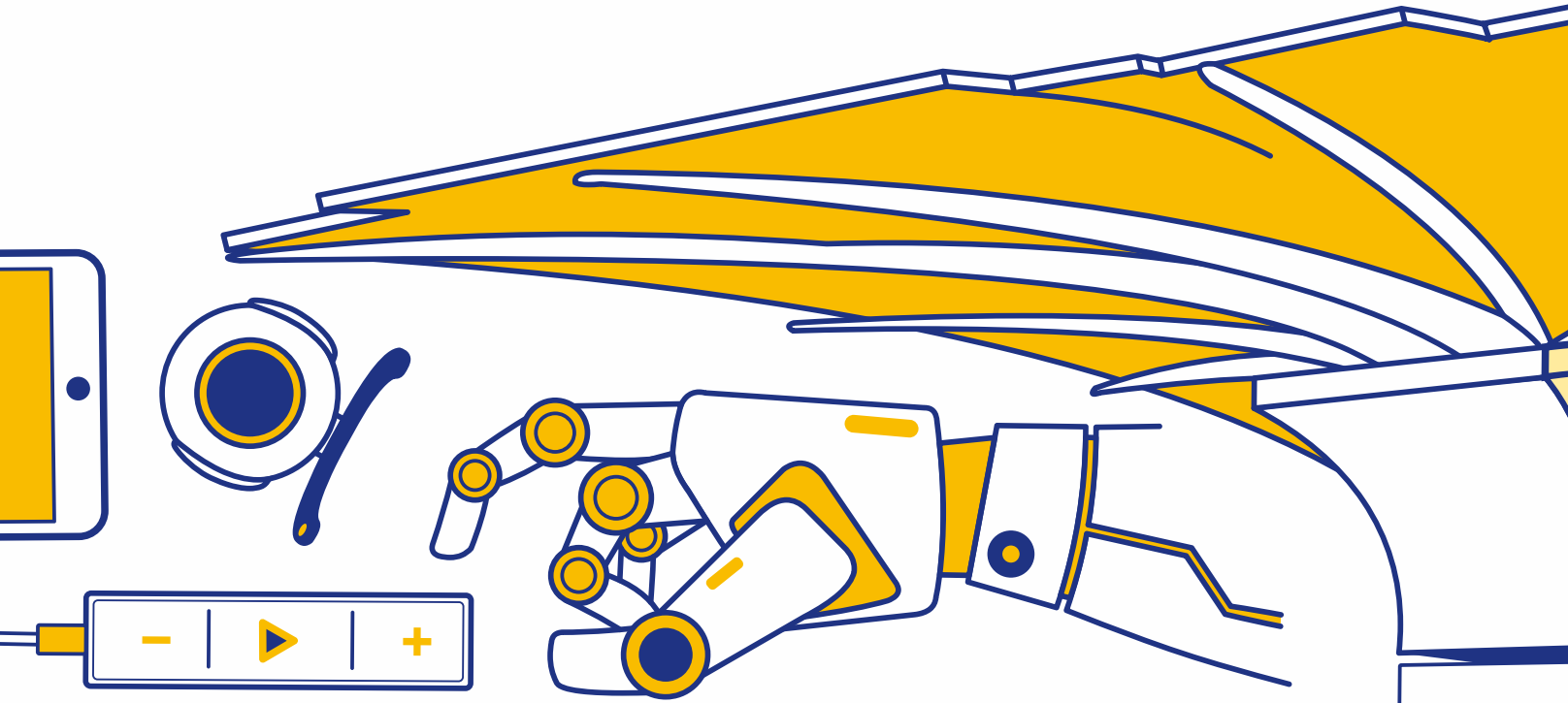

MINISTRY  
OF ECONOMIC DEVELOPMENT,  
TRADE AND AGRICULTURE OF UKRAINE

Ukraine  
**NOW** ua



Second Edition

# Ukrainian innovative products

 **Innovate  
with  
Ukraine**



# LIST OF UKRAINIAN INNOVATIVE PRODUCTS

2	SMART OASIS	fully autonomous modular system for independent water production
3	ABRIS (FLIRT)	flying intelligent robotic tools
4	Accamedin	innovative postgraduate education for physician (e-learning for medical specialists)
5	ALT	additive laser technologies of Ukraine
6	ARBrowser	AR SaaS for furniture retailers
7	ChiPeer	spot, earn & save on overseas shopping, easily
8	CLAP	the ultra-modern home control system
9	EdPro (Amperia)	school equipment for labs
10	ELEEK	the next step in bicycle evolution
11	Esper Bionics	the new level prosthetic hand solution
12	Hideez	identity and access management solutions for business and personal use
13	Hushme	world's first voice mask for smartphones
14	Jollylook	vintage analogue instant cameras from recyclable materials
15	Kodisoft	the first interactive, multi-touch table
16	Limpid Armor	360 vision - unique dual-use solution for the modernization of heavy vehicles
17	Meredot	empowering wireless power transmission
18	PassivDom	autonomous intelligent house
19	PatentBot	a chatbot in Facebook messenger that helps automate the trademark registration process
20	Photon LMS	the most advanced portable mini studio with constant led lighting for detailed object shooting
21	PiPillow	a personal device, that helps you to enjoy every minute of your sleep
22	Pix	digital customizable backpack
23	Raccoon.Recovery	a goal-oriented physical rehabilitation tool based on big data, ML technology and video gaming
24	Senstone	portable voice assistant
25	TenniRobo	compact professional table tennis robot
26	UBreez	the first shareable air quality monitoring system
27	UGEARS	unique self-propelled mechanical models
28	VoxBox	virtual reality for therapy, trainings and education
29	Whooshi	Bluetooth 5.0 hi-fi headphones' amplifier
30	xBeam 3D	revolutionary industrial metal 3D printers



SMART OASIS

## SMART OASIS IS FULLY AUTONOMOUS MODULAR SYSTEM FOR INDEPENDENT WATER PRODUCTION

"SMART OASIS is on a mission to prevent humanity from a global water crisis that we'll face in the next 10 years by massively optimizing usage of the water by the agricultural industry and solar panel parks. Tapping into the market we provide fully autonomous and 100% sustainable water modules for governments and businesses".

### MAIN INDUSTRIES

Smart Device, R&D, Drinking Water, Innovations.

### PRODUCT UNIQUENESS

SMART OASIS is a unique, fully autonomous modular system for independent zero-carbon water production. Solar powered. 100% sustainable. Easily scalable. The power of the sun and the air in your glass. We are revolutionizing the production of drinking water and optimizing food growing methods. We have 3 product lines: city – a fully autonomous water fountains that produce 55 litres of drinking water per day with zero-waste; smart farming – we created a fully autonomous greenhouse that can grow 3000 kg of greens per year even in the middle of the desert with no access to water and other utilities; solar – we developed autonomous cleansing distilled water modules that are increasing the productivity of the solar park by 25% and cutting expenses on human labour.

click on the icon



**VIDEO  
PRESENTATION**

### MORE DETAILS



Website



Facebook

### PRODUCT IN THE MEDIA

Water from air:  
how Ukrainians  
built a "smart  
oasis" on the  
beach of Dubai

Ukrainian invention  
produces drinking  
water from air in  
Dubai's smart park

SMART OASIS

CEO, Mr. Alex Prykhodko

E-mail: pa@weareida.com

Tel.: +380938559000

CMO, Mr. Yurii Tarasiuk

E-mail: yt@weareida.com

Tel.: +380932301226

# FLYING INTELLIGENT ROBOTIC TOOLS

"ABRIS DG is a company that unites experienced professionals from different fields of knowledge: aircraft design and aerodynamics, control systems, technology, programming, geodesy. This is a group of professionals who are fascinated with a common goal – the creation of effective unmanned systems for aerial photography".

## MAIN INDUSTRIES

Technology, Programming, Aircraft Design, Aerodynamics.

## PRODUCT UNIQUENESS

FLIRT is a powerful professional tool for aerial mapping, monitoring and other remote sensing applications. The solution combines all the advantages of unmanned flying systems with high standards and performance of large specialized aircrafts. The defining new feature of FLIRT (unlike many other unmanned aircraft systems) is the ability to get a series of well-aligned images even in a strong crosswind.



click on the icon



**VIDEO PRESENTATION**



## MORE DETAILS



Website



Facebook

## PRODUCT IN THE MEDIA

ABRIS DG drones capture mapping data in extreme conditions



CEO, Ms. Liudmyla Sec

E-mail: [abris@abris.aero](mailto:abris@abris.aero)

Tel.: +380955807979;

+380675380215

ABRIS DG

# acce med in

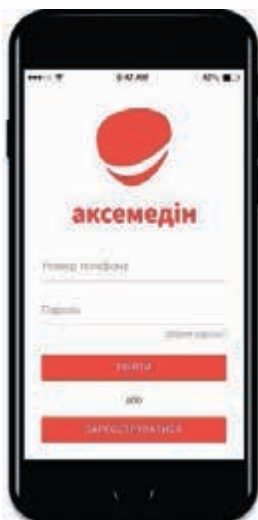
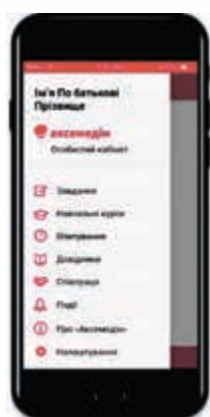
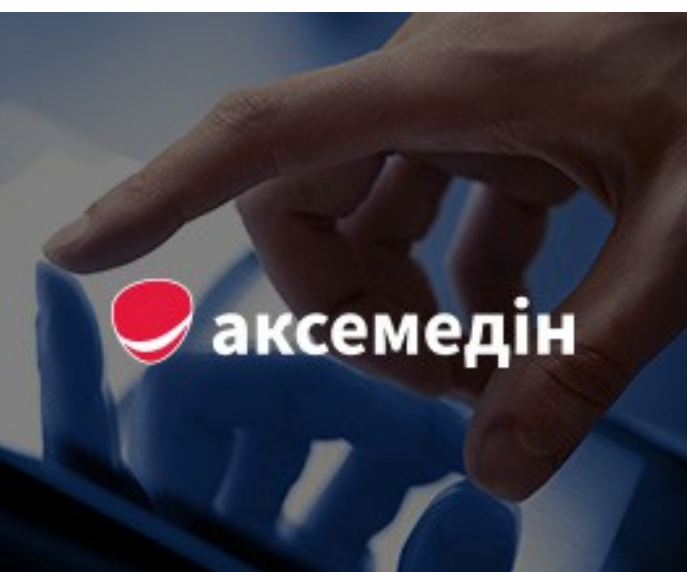

Accemedin

## INNOVATIVE POSTGRADUATE EDUCATION FOR PHYSICIAN (E-LEARNING FOR MEDICAL SPECIALISTS)

"Accemedin is a modern platform that helps physicians to develop medical knowledge and skills and to avoid medical mistakes in their future practice. It is the new unique multichannel online platform for the postgraduate development of physicians. We help doctors to make the right decision in their medical practice".

### MAIN INDUSTRIES

Education, Healthcare, Medicine, Self-development.

### PRODUCT UNIQUENESS

Accemedin is an informational and educational environment for physicians. Postgraduate e-learning with Accemedin gives doctors the opportunity to receive postgraduate education in the form of courses, webinars, online-conferences. All of them are certificated by the orders of the Ministry of Health of Ukraine and international accreditation requirements. Every doctor has the opportunity to become an author on the platform. Accemedin is the main news and content aggregator in Ukrainian medicine. We were first to use AR-technologies in medical journalism. With our AR-application, we create an informational channel that unites options and resources of the press and digital technology. This way, we help doctors to take their everyday clinical decisions. With Accemedin medical practitioners are able to develop their professional skills using educational content of the leading Ukrainian speakers. As we go forward, we are going to add speakers from 27 economically developed countries.

click on the icon



VIDEO  
PRESENTATION

### MORE DETAILS



Website



Facebook

### PRODUCT IN THE MEDIA

В Україні створили унікальний журнал із живими зображеннями



Inventor, Mr. Sergiy Soshunskiy

E-mail: support@accemedin.com,

s.soshynskiy@accemedin.com

Tel.: +380674666493

# ADDITIVE LASER TECHNOLOGIES

“Professional 3D printing with metals becomes easier with ALT!”

## MAIN INDUSTRIES

3D technologies, IT equipment.

## PRODUCT UNIQUENESS

Additive Laser Technologies of Ukraine is a manufacturer of 3D printers for metal printing using selective laser melting technology. 3D printing with metal alloys is the most advanced technology of manufacturing complex and significant structural elements in aerospace, medicine and engineering spheres. Additive technology – to compare – makes it possible to save on average \$2-3 million on the production of one aircraft. Additive technology is also much more flexible and allows introducing and creating new models without interrupting the manufacturing process for retooling. This reduces manufacturing time and increases the rate of introduction of more modern and cost-effective samples. In addition, 95-98% of waste in 3D printing can be reused, and, additive production has an environmental impact of 70% less than conventional processing.

click on the icon



**VIDEO  
PRESENTATION**

## MORE DETAILS



Website



Facebook



Linkedin

## PRODUCT IN THE MEDIA

Smarttech3D Universe 5MPix with visit on the fair in Ukraine



CEO, Mr. Sergii Adjamskyi  
E-mail: info@alt-print.com  
Tel.: +380987206127

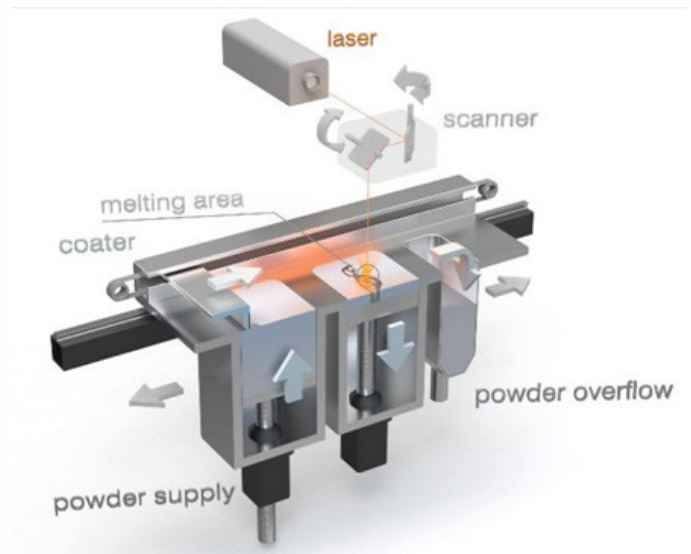

ALT

Augmented  
reality SaaS  
for e-commerce  
and retail



# ARBROWSER - AR SAAS FOR FURNITURE RETAILERS

"We promote augmented reality technology among the mass audience by allowing them to purchase goods in a new more attractive ways and having a fun experience while doing that".

## MAIN INDUSTRIES

Augmented reality technology, E-commerce, Sales.

## PRODUCT UNIQUENESS

ARBrowser - AR SaaS for furniture retailers.  
ARBrowser provides a 3D cloud platform and AR furniture app builder to "virtually" display selected furniture in its real size and different colors or fabrics. Helps drive 20% more sales.

click on the icon



VIDEO  
PRESENTATION

## MORE DETAILS



Website



Facebook

## PRODUCT IN THE MEDIA

Ukrainian start-up named to the global  
program EY Accelerating Entrepreneurs 2018



Inventor, Mr. Anton Potikha  
E-mail: ap@arbrowser.co  
Tel.: +380638824250

# SPOT, EARN & SAVE ON OVERSEAS SHOPPING, EASILY. CHIPEER

“ChiPeer’s team is transforming the way online fashion shoppers do overseas purchases. Imagine Instagram, powered by P2P economy, where you can do overseas shopping at retail stores as if you were there personally”.

## MAIN INDUSTRIES

Cross-border E-commerce, Fashion Shopping, Collaborative Economy, Crowd-shipping, Social Shopping.

## PRODUCT UNIQUENESS

Core purposes of ChiPeer’s platform (Web, iOS, Android mobile Apps) are (1) for Shoppers: to deliver an extraordinary value based on user experience, price & accessibility advantages while doing overseas fashion shopping at brick-and-mortar stores around the world; (2) for Micropreneurs: to earn money & grow reputation while helping others save on cross-border purchases on sales at retail & online stores.

With that in mind, the ecosystem has the following features: super easy, Instagram-like UX; personalization and curation, fashion influencers; fair pricing, no hidden commissions; fashion & brand trade deals are always free to publish; all purchases are secured; fast in execution & delivery; VAT refund when applicable; content & users’ work monetization.

## MORE DETAILS



Website



Instagram



Facebook



LinkedIn

## PRODUCT IN THE MEDIA

The evolution of online shopping – why e-commerce is the new reality

How has e-commerce conquered post-soviet countries?



CEO, Mr. Dmytro Barbarchuk  
E-mail: db@chipeer.com  
Tel.: +380735112631

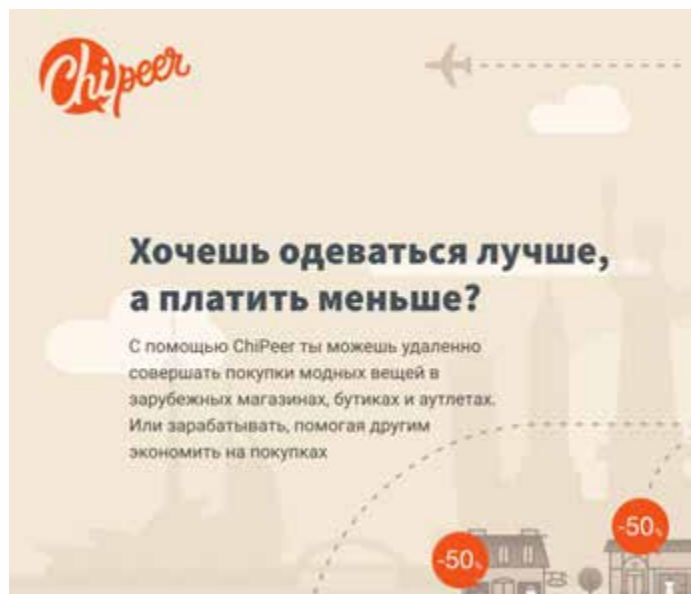

ChiPeer



# THE ULTRA-MODERN HOME CONTROL SYSTEM

"We strive to make the life of every person comfortable and safe; therefore we invest all our strength and capabilities in our developments, and do not stop at what has been achieved".

## MAIN INDUSTRIES

Smart Home System, Security System, IT Equipment.

## PRODUCT UNIQUENESS

Next generation wireless smart home system, that provides security and comfort at the same time, as well as helps to use energy efficiently and to save money on utility bills. Benefits: unique technology (own wireless radio technology MORION, interaction at a distance of up to 1500 meters, two-way communication support, instant alerts sending); seamless performance (operability with standard batteries up to 5 years, backup power supply for emergency cases, 3 serial communication channels: GSM, Ethernet, Wi-Fi, simultaneous connection of up to 300 devices); absolute invulnerability (multi-channel communication encryption, protection against viruses, intrusions and jamming, device authentication, built-in tampers and accelerometers); ease of use (installation without special skills; adding devices using QR-code, remote control, setup and diagnostics, full mobility).



click on the icon



**VIDEO PRESENTATION**

## MORE DETAILS



Website



Facebook



LinkedIn

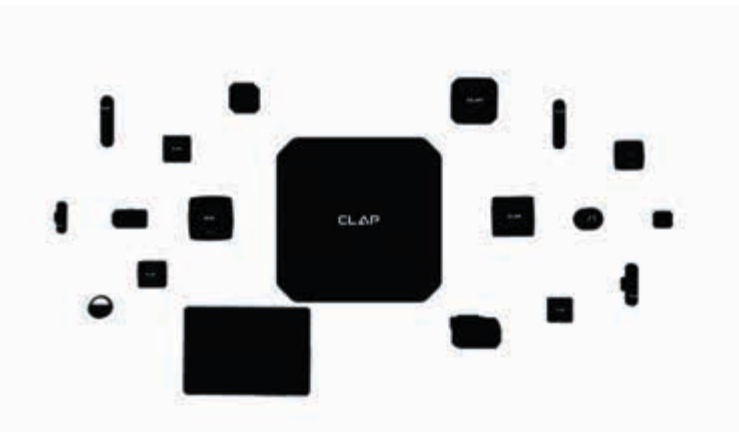

CLAP



Head of Sales, Mr. Evgen Avdieienko

E-mail: a.evgen@clap.ua

Tel.: +380509890055

# EDPRO AMPERIA SCHOOL EQUIPMENT FOR LABS

"In the educational process labs execution is a crucial element, since it is impossible to properly assess theoretical knowledge without practical experience. Our goal is to ensure that children during the lab, in addition to planned experiments, have the opportunity, time and desire to explore the topic more deeply".

## MAIN INDUSTRIES

Education, Measuring equipment.

## PRODUCT UNIQUENESS

Patented magnetic connection of the elements. It provides a rapid collection of schemes during the class. The faster the scheme is collected, the more tasks can be done, and the results could be analysed more qualitatively.

Mobility. The kit does not require external wired power supplies. The kit includes a power supply that runs on the built-in battery. This solution makes possible to carry out labs in any room, hence saving on expensive repair and rapid implementation.

Practicality and modernity. Wi-Fi, built-in power supply and measuring device, allows children to analyse data on tablets or computers and to conduct complex experiments during a limited time in the class. The kit incorporates the principle of combining modern approaches with classical elements that increases the interest to science in modern children.

R&D-ed in Ukraine, made in Ukraine and is a unique solution on the world market.



## MORE DETAILS



Website



Facebook

## PRODUCT IN THE MEDIA

EdPro: стартапи,  
які зроблять  
навчання  
цікавішим

Як українська компанія  
змінює шкільну освіту  
за допомогою  
технологій?



CEO, Mr. Yuriy Tabachyn  
E-mail: info@edpro.ua  
Tel.: +380322492029



EdPro



# ELEEK BIKES IS THE NEXT STEP IN BICYCLE EVOLUTION

"The electric bicycle is a thing that gives you sincere emotions, opens up new horizons and opportunities".

## MAIN INDUSTRIES

Ecology, Sports, Extreme Sports, Deliver.

## PRODUCT UNIQUENESS

ELEEK company has developed and patented electric bicycle frames based on which we create a complete set of electric bicycles. Modern development of scientific and technological progress allows us to use our electric bicycles in various areas of social life, such as active rides on the ground mountain roads or in the metropolis wearing a business suit. We will show to the general public the urgency of the issue of transition to alternative means of transport in order to preserve the environment and save money. Electric bike needs only minimal maintenance: everything is simple and thought out. High dynamics of movement allows you to develop speed in a short period of time, namely from 0-60 km/h in 3 seconds with a range of mileage up to 500 km from one charge. Implementation of customer wishes and a wide range of accessories including GPS-GSM positioning system, signalling, 5/12V for charging portable devices. Ability to install additional options such as trunk, pizza boxes, trailers, children's seats.

click on the icon



**VIDEO  
PRESENTATION**

## MORE DETAILS



Website



Facebook



Inventor, Mr. Pavlo Rudakevych  
E-mail: [eleekbikes@gmail.com](mailto:eleekbikes@gmail.com)  
Tel.: +380673878768

ELEEK

# THE NEW LEVEL PROSTHETIC HAND SOLUTION

"We believe that a human life capacity is much underestimated, and people can live during a lifetime twice more; that our body should not be the limit anymore and should be upgraded. So, we have started the project with the exact long-term goal - to make a huge impact on longevity and saturation of human life".

## MAIN INDUSTRIES

Medicine, Digital Health, Healthcare, Physical Rehabilitation.

## PRODUCT UNIQUENESS

Esper Bionics developed the first prosthesis that learns users, and day by day becomes a unique tool, that understands her. ESPER HAND is the first prosthetic hand that uses Machine Learning approach to develop stable, convenient control individually for each user. It provides intuitive control: prosthesis will recognize the situation in which the user is and will intuitively select the right grip. Also, unique modular design of ESPER HAND allows to: replicate a shape of a hand (from a female teenage hand to a male basketball player hand); be affordable for users from developing countries (depending on different prosthesis combination the price can vary for each market); simplify the service by replacement of a component in 5-10 minutes at home or prosthetic clinic.

click on the icon



VIDEO  
PRESENTATION

## MORE DETAILS



Website



Facebook

## PRODUCT IN THE MEDIA

Esper Bionics: «рука допомоги» з України

Український стартап виготовить доступні біонічні протези



Inventor, Mr. Dmytro Gazda  
E-mail: hello@esperbionics.com  
Tel.: +380669419437



ESPER  
B I O N I C S



Esper Bionics

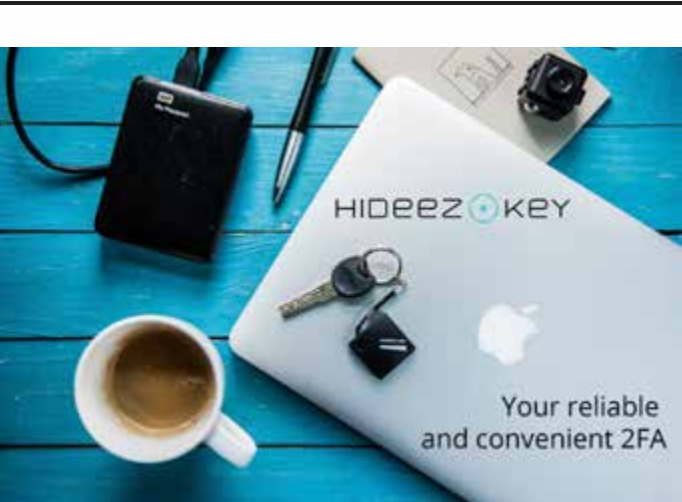

Hideez

## IDENTITY AND ACCESS MANAGEMENT SOLUTIONS FOR BUSINESS AND PERSONAL USE

"The idea arose based on my own user experience when I had to remember a lot of different passwords and very often needed to enter them manually. There was a situation when my social media account, email was hacked and money was stolen from my bank account. This led me to the idea of how this problem can be solved. First of all for myself".

### MAIN INDUSTRIES

IT Technology, Cybersecurity, Blockchain.

### PRODUCT UNIQUENESS

Hideez – the cybersecurity company creates easy-to-use, comprehensive authentication solutions that support reliable and convenient digital identity and physical access. The gadget consolidates all authentication standards - passwords, two-factor authentication, digital signature, Blockchain Signature, and electronic locks. Hideez Key – is a clever combination of a digital and physical authenticator with Bluetooth and RFID/NFC capabilities. Hideez key provides hands-free PC access – no passwords or card swiping. It is compatible with popular existing enterprise infrastructure solutions. Hideez solutions increase employee productivity by reducing lost passwords. Our products and services support compliance & risk mitigation policies. They also protect against identity theft, phishing, credential stuffing, and account takeovers.

click on the icon



### MORE DETAILS



Website



LinkedIn

### PRODUCT IN THE MEDIA

Hideez key review – you should not buy it before read this

Hideez: Ukraine's pivoting start-up

Streamline and secure your life with the Hideez Key 2, a universal key

Ключ від інтернету. Історія українського стартапу Hideez



Inventor, Mr. Oleg Naumenko

E-mail: on@hideez.com, info@hideez.com

Tel.: +380672147477

# WORLD'S FIRST VOICE MASK FOR SMARTPHONES

"Hushme is a personal acoustic device that protects speech privacy and reduces noise pollution when speaking on the phone in the open space environment".

## MAIN INDUSTRIES

Consumer Goods, Wearables, Wireless Devices, Mobile Accessories, Gaming.

## PRODUCT UNIQUENESS

Very often we come across a situation when we need to answer or make an important call, but there is no way we can do this, mainly, because we don't want to bother people around, as well as we don't want them to eavesdrop on our conversation. Now there is a solution to avoid such inconvenience – Hushme. Unlike other existing alternative solutions, Hushme provides a possibility of preserving speech privacy and reducing noise pollution in a convenient and effective way. It has three modes: normal headset mode, passive voice muffling mode and active voice masking mode.

click on the icon



**VIDEO  
PRESENTATION**

## MORE DETAILS



Website



Facebook

## PRODUCT IN THE MEDIA

CES 2018:  
Hushme mask  
lets users make  
private calls

How to keep your  
chatty colleagues  
quiet: Bizarre "Darth  
Vader" mask can  
mute loud phone  
conversations

An end to  
overhearing  
annoying phone  
calls? This mask  
silences private  
conversations

Hushme muzzle keeps phone calls  
private and drowns out your voice  
with Darth Vader sound effects

Hushme's voice-masking  
headset could save your  
sanity



Inventor, Mr. Oleksand Nesterenko  
E-mail: info@gethushme.com  
Tel.: +380504422090



Hushme

# VINTAGE ANALOGUE INSTANT CAMERAS FROM RECYCLABLE MATERIALS

"When moments of life that we see freeze on paper - it is a magic!"

## MAIN INDUSTRIES

Photography, Analogue Snapshot, Technology.

## PRODUCT UNIQUENESS

Jollylook is a simple fold-out camera for analog photos, made entirely from recycled paper and cardboard. No electronics, batteries or chargers - some paper, a pair of lenses and a cartridge for instant mini photos. Vintage Design - retro with a little steampunk. Fold-out and Compact - a little bigger than an iPhone box. A Great Gift - can be used immediately and instantly. A Great Toy - Jollylook is a great teaching toy for children. Your kid can take it apart and see how it works.

A Great Souvenir - even after use Jollylook is beautiful on the shelf! Fun - entertaining and positive emotions. Beautiful Photos - using Instax mini film you get 10 instant classic color or monochrome analog unique photos. Environmentally friendly.

click on the icon



**VIDEO PRESENTATION**

## MORE DETAILS



Website



Facebook



Instagram



Twitter

## PRODUCT IN THE MEDIA

This vintage-looking cardboard instant camera is a hipster dream

Jollylook is the first cardboard folding instant film camera

Jollylook vintage instant cardboard camera

The Jollylook: a vintage style instax film camera made from cardboard

Now on Kickstarter, this low-tech paper camera shoots instant photos without electricity

Inventor, Mr. Oleg Khalip  
E-mail: [hello@jollylook.photo](mailto:hello@jollylook.photo)  
Tel.: +380632431080

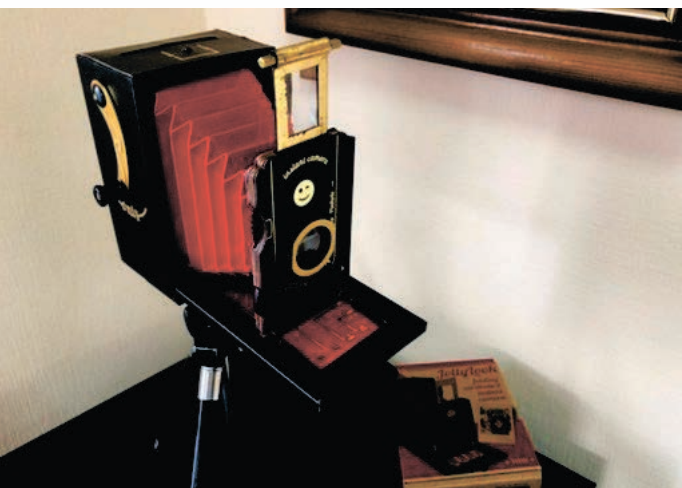

Jollylook

# THE FIRST INTERACTIVE, MULTI-TOUCH TABLE

"I have always wanted to create something not only unique but also useful for society".

## MAIN INDUSTRIES

Interactive System, Interactive Technologies, Furniture.

## PRODUCT UNIQUENESS

This is only one table in the world that can be used in public environments such as restaurants due to its durability - our technology can recognize touches through up to 20 mm of glass, that's why our table so strong!  
Every visitor can touch the table surface to order menu items and services, play games, and make sure it's the first interactive table that really works.

click on the icon



**VIDEO  
PRESENTATION**

## MORE DETAILS



Website



Facebook



Linkedin

## PRODUCT IN THE MEDIA

Bringing a new solution to the table: interactive technology transforms the restaurant industry

Kodisoft develops innovative, interactive smart tables



Inventor, Mr. Dmytro Kostyk  
E-mail: dk@itrestaurant.net  
Tel.: +380932394409

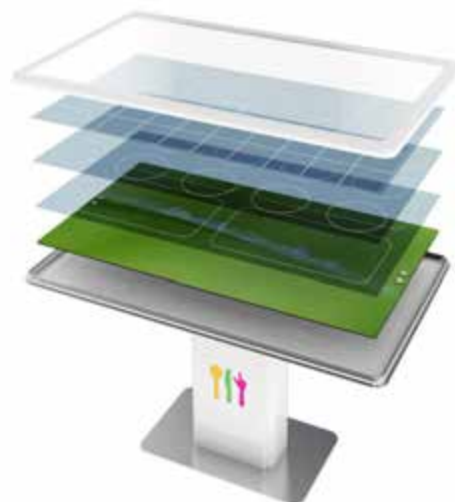

Kodisoft



## 360 VISION - UNIQUE DUAL-USE SOLUTION FOR THE MODERNIZATION OF HEAVY VEHICLES

"The economy of the future is a symbiosis of people and machinery. Our technologies help to replace people and to save their lives in especially hazardous conditions!"

### MAIN INDUSTRIES

Enterprise & Industry, Military.

### PRODUCT UNIQUENESS

360 vision consists of augmented reality glasses integrated into a helmet or/and screens with a simple and intuitive interface that allows crews to perform missions effectively. Camera modules outside the vehicle provide a 360-degree real-time view for the operator. Our own software ensures recognition of important objects, data visualization, including telemetry of all systems of the vehicle, task statuses, goals, interactive hints, placement of units. It can receive data from the UAV.

The product uniqueness lies in its modularity and the ability to be installed on any type of ground vehicles. 360 vision is fully customizable according to customer's requirements - the number and type of cameras, types of recognizable objects, screen or AR display solutions, the variability of interface elements. Land Platform Modernization Kit (LPMK) - our military solution - is developed based on AR standards for NATO we are working on.

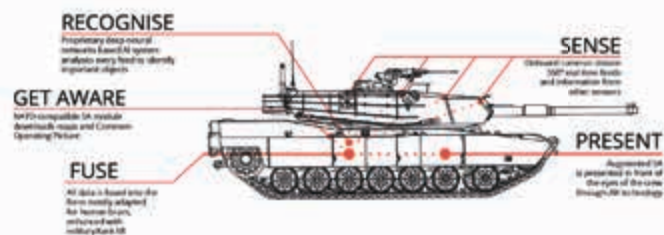

click on the icon



### MORE DETAILS



Website



Facebook



Twitter

### PRODUCT IN THE MEDIA

The see-through tanks are coming

HoloLens for tanks will augment the reality of war

Ukrainian military eyes Microsoft HoloLens for next generation of tank warfare

Microsoft's HoloLens headset will allow real tank operators to see the battlefield outside



CEO, Mr. Mykhailo Grechukhin

E-mail: info@limpidarmor.com

Tel.: +380960371390

limpidarmor.com

# EMPOWERING WIRELESS POWER TRANSMISSION

“Over-the-air wireless charging is a key factor for autonomous ecosystems and Meredot technology is enabling it”.

## MAIN INDUSTRIES

Electric Vehicles, Consumer Electronics, Robotics.

## PRODUCT UNIQUENESS

Meredot develops a next generation magnetic field-shaping technology for charging electric vehicles, robots and consumer electronics on the distance up to 30 cm. Meredot's power and efficiency rates, it's seamless UX are true game changers. The charging station can be integrated into any surface and charge devices at the same speed as a cable on up to 30 cm distance. Meredot team envisions the future with no cables, autonomous vehicles, and the time when we can, at last, lose track of our phone battery status.

click on the icon



**VIDEO  
PRESENTATION**

## MORE DETAILS



Website



Facebook



Instagram



Inventor, Mr. Roman Bysko  
E-mail: io@meredot.com  
Tel.: +380932951398



Meredot

# AUTONOMOUS INTELLIGENT HOUSE

"PassivDom is absolutely ZERO carbon emissions housing solution for cold and hot climates; off-the-grid solar only energy; prefabricated intelligent house".

## MAIN INDUSTRIES

Design, Architecture, 3D Construction Software, Passive Homes.

## PRODUCT UNIQUENESS

IOH - Internet of Houses. Extremely high energy efficiency. Low thermal losses. Up to 20 times less energy consumption for heating and cooling. House frame produced by additive 3D-printing technology. Walls, roof and basement printed simultaneously, the house frame is a one-piece detail without connections. No thermal bridges. Autonomous Home Energy management and distribution software. AI-powered prediction algorithms. The autonomous house can operate itself and make own decisions 6 glazed windows with infrared absorption and thermal energy storage. 99.9% viruses and bacteria protection. Healthcare engineering.

## MORE DETAILS



Website



Facebook



Crunchbase

## PRODUCT IN THE MEDIA

Startup 3D prints smart homes that run off-grid on solar power

PassivDom is a Zombie-proof "autonomous 3D-printed mobile house"

Modern home in Ukraine by PassivDom

A robot can print this \$64,000 house in as few as 8 hours – take a look inside

PassivDom is now taking pre-orders for totally Autonomous 3D Printed Houses



### Ukraine office

43/16 Velyka Vasylkivska st,  
Kyiv, Ukraine, 01024  
Tel.: +380675065069  
info@dom.ai

### USA office

250 Chism st, Reno, NV 89503  
Tel. +14158495140



PassivDom

# A CHATBOT IN FACEBOOK MESSENGER THAT HELPS AUTOMATE THE TRADEMARK REGISTRATION PROCESS

"Our global goal is to become a transatlantic patent office. Any resident from any country can register a trademark globally just in a few minutes".

## MAIN INDUSTRIES

Legaltech.

## PRODUCT UNIQUENESS

This is the first bot in the world that provides trademark registration services online. PatentBot is the Bot of the 2017 Year by Product Hunt. For more than 2 years, PatentBot has helped to register trademarks in the USA, EU, and Ukraine. In 2019 we've added China & CIS countries. It is a quick, easy, and cheap way to protect your IP rights.

click on the icon



**VIDEO PRESENTATION**

## MORE DETAILS



Website



Facebook

## PRODUCT IN THE MEDIA

Стартап – торгова марка – патент. Як захистити бізнес-ідею і не розоритися

Український бот – реєстратор торгових марок – виходить на ринок Євросоюзу



CEO, Ms. Natalia Vladimirova  
E-mail: me@patentbot.online  
Tel.: +380931705244





# THE MOST ADVANCED PORTABLE MINI STUDIO WITH CONSTANT LED LIGHTING FOR DETAILED OBJECT SHOOTING

"We do the work of photographers FASTER, BETTER & MORE CONVENIENT by saving his TIME & MONEY!"

## MAIN INDUSTRIES

Portable Photo Studio, Objective Shot, Professional Equipment.

## PRODUCT UNIQUENESS

A completely ready-to-use solution straight out of the box. Get the set and you can immediately shoot. Simple installation - does not require any professional skills. Plus, it is much cheaper than the studio equipment. Placing, space savings - 1/4m<sup>2</sup> in contrast to 3m<sup>2</sup>. Speed - instant change of lighting map. Visibility - when lighting is constant on the object, you instantly see the result of the lighting map. Skills - at home, in the office or shop you can easily get quality content without any photography skills.



## MORE DETAILS



Facebook



Instagram



Inventor, Mr. Iaroslav Neliubov  
E-mail: photonmodule@gmail.com  
Tel.: +380982833333

# A PERSONAL DEVICE, THAT HELPS YOU ENJOY EVERY MINUTE OF YOUR SLEEP

"A person dedicates a third of her life to the sleep, so it is worth making this process as pleasant as possible. It was important to place the entire hardware part properly, make it impenetrable through the fabric. Several prototypes and different types of material have been tested to come to what we have now".

## MAIN INDUSTRIES

IT equipment, Smart device, Health.

## PRODUCT UNIQUENESS

The PiPillow is a revolutionary product that solves a lot of problems that have been left untouched. This is the first device in the world that combines all the functions that are necessary for perfect sleep: from listening music to tracking sleep phases and helping people with Apnoea. The device allows you enjoying music or audiobooks, stops playback as soon as a person falls asleep. PiPillow tracks the user's sleep phases, records the severity and frequency of breathing, records any other sounds. In the morning, the same pillow helps the owner to wake up at the most comfortable moment for that. All data on sleep quality or possible health problems can be viewed by using the smartphone app. The simplicity of usage and beautiful design along with customizable options, make it perfect to use, not only for adults but even for children. And more importantly, it is safe.

click on the icon



**VIDEO  
PRESENTATION**

## MORE DETAILS



Facebook

## PRODUCT IN THE MEDIA

Ukrainian researchers, entrepreneurs break the walls in Berlin

Винахідник "розумної подушки" Олександр Шиманко в Берліні став "Молодим інноватором 2015 року"

Олександр Шиманко, студент-інноватор, автор "розумної подушки"



Inventor, Mr. Oleksandr Shymanko  
E-mail: Oleksandr.shymanko@gmail.com  
Tel.: +380669909772



PiPillow



# DIGITAL CUSTOMIZABLE BACKPACK

"We wanted to create a universal tool to help people express their feelings and emotions in seconds using such everyday thing as a backpack".

## MAIN INDUSTRIES

Fashion, Animations, Widgets, Games.

## PRODUCT UNIQUENESS

Digital customizable backpack, with a built-in programmable LED screen which appearance can be changed with just a few taps on a smartphone. The design of Pix can be modified with a dedicated, free companion app for Android or iOS. The backpack is powered by a standard power bank. Using a 20,000 mAh power bank allows the LEDs to operate continuously for 12 hours. Users can either choose from a vast library of pixelized images/animations/widgets/games or create their own pixel art using the editor included in the app.

click on the icon



**VIDEO  
PRESENTATION**

## MORE DETAILS



Website



Facebook



Instagram

## PRODUCT IN THE MEDIA

The Pix Backpack is a wearable screen for the hypebeast generation

This pixel animation backpack has crossover appeal for kids and ravers

We have to get our hands on Pix, the Kickstarter-funded animated backpack

Pix lets you put electronic images on your smart backpack



CEO, Ms. Margaret Rimek

E-mail: info@pix.style,

margaret@pix.style

Tel.: +15612830375

# RACCOON.RECOVERY IS A GOAL-ORIENTED PHYSICAL REHABILITATION TOOL BASED ON BIG DATA, ML TECHNOLOGY AND VIDEO GAMING

"We strive to improve the quality of life of people after injuries and neurological diseases by creating technological solutions. To solve that we create smart devices and high-tech software using Big Data and Machine Learning technologies and combine it into a complete solution".

## MAIN INDUSTRIES

Digital Health, Healthcare, Physical Rehabilitation.

## PRODUCT UNIQUENESS

Raccoon.Recovery is a physical rehab tool:

- software and hardware components;
- Machine Learning for mistake-proof treatment courses;
- gaming to motivate and increase the number of repetitive movements;
- we collect Big rehab Data and create Esperanto in physiotherapy.

Our solution helps to treat more patients at a time and increase the revenue for rehab centres by 40%.

## MORE DETAILS



Website



Facebook



LinkedIn



Twitter

## PRODUCT IN THE MEDIA

How this startup is using machine learning in physical rehabilitation

Helping Hands: a goal-oriented physical rehabilitation tool based on video gaming

Episode 044 — meet CEO Lana Malovana and Raccoon.Recovery

Raccoon.World rehabilitation solution for people with hand disabilities



CEO, Ms. Svitlana Malovana  
E-mail: general@raccoon.world





Portable Voice Assistant

TOUCH & SPEAK!



# SENSTONE: PORTABLE VOICE ASSISTANT

"We help busy professionals to save time, increase work efficiency, organization and focus with our portable voice assistant".

## MAIN INDUSTRIES

Gadgets, IT Technology, Software.

## PRODUCT UNIQUENESS

Senstone is a physical device that you wear, talk to and then it comes out in text. We then use AI to organize notes with keywords and hashtags. It helps our customers stay productive during a commute in the cars and between meetings remaining handsfree in today's mobile world. The core of innovation is a voice-enabled assistant that lets people quickly capture important information. In some situations, looking at the phone screen is impossible and sometimes, like when driving, dangerous. With our solution, people just speak handsfree and we take care of the rest. Patentable solution is a combination of small smart connected device and AI-powered software system.

click on the icon



**VIDEO  
PRESENTATION**

## MORE DETAILS



Website



Facebook



Linkedin

## PRODUCT IN THE MEDIA

This tiny device can record everything you say and transcribe it for you

This wearable can record everything you say – then write it down

Senstone, il gioiello che trasforma la nostra voce in testo

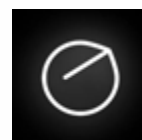

Inventor, Mr. Nazar Fedorchuk  
E-mail: team@senstone.io

Senstone

# COMPACT PROFESSIONAL TABLE TENNIS ROBOT

"TenniRobo is the most compact and one of the most advanced professional table tennis robots in the world. It can be the first step for a beginner, a great partner for any player, or a great assistant for a coach".

## MAIN INDUSTRIES

Robots, IT Technology, Games, Trainer.

## PRODUCT UNIQUENESS

TenniRobo is an innovative compact robot for table tennis that combines a skillset of the professional trainer with intuitive control via the mobile application. After connecting the robot to the smartphone via Bluetooth, the user can recreate realistic, human-like, shots (and combination of shots) of any complexity. TenniRobo provides all the features needed for the professional training, but unlike other table-tennis robots has an extremely compact size. It is lightweight and portable, so a player could put it in a backpack and bring it anywhere. Also, unlike almost all the other existing models of robots, it simulates a completely natural behavior of a ball, so the player always has a space for self-improvement. It provides a great ratio price/functionality and a few unique features competitors do not have: digital control over all the ball parameters (spin/speed/time/trajectory), fast and intuitive Bluetooth control via own mobile app and IR remote.

click on the icon



**VIDEO  
PRESENTATION**

## MORE DETAILS



Website



Facebook

## PRODUCT IN THE MEDIA

Founder Interviews: Sergey Vasylyev of TenniRobo

Best Ping Pong Robots (Reviews & Buyer's Guide 2019)



Inventor, Mr. Sergii Vasylyev  
E-mail: [tennirobo@gmail.com](mailto:tennirobo@gmail.com)  
Tel.: +380974290723

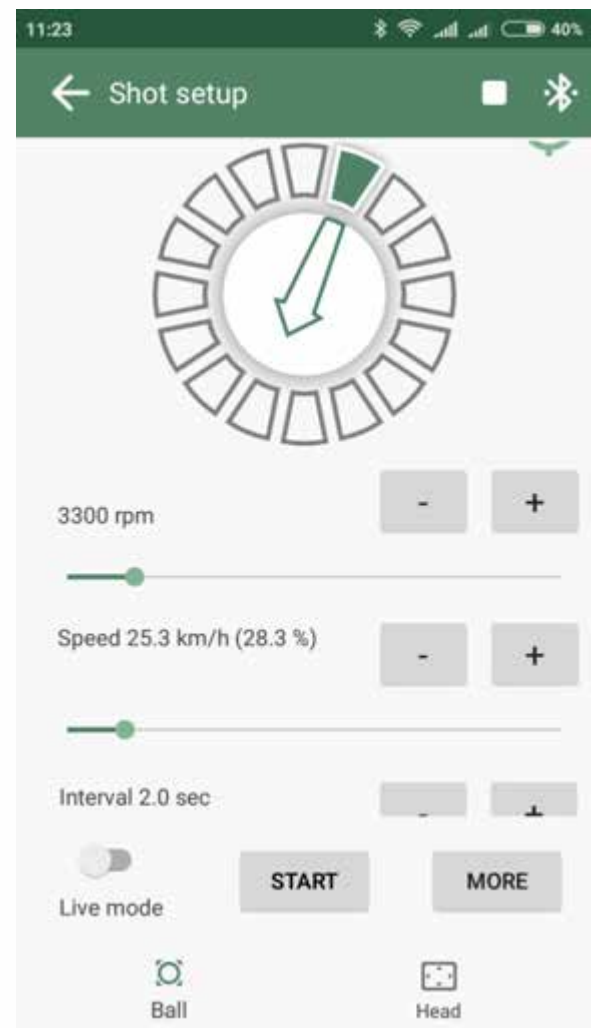

TenniRobo



# THE FIRST SHAREABLE AIR QUALITY MONITORING SYSTEM

“Every breath matters. That is why you need UBreez to “see” the air you consume”.

## MAIN INDUSTRIES

IT Equipment, Smart Device, Health.

## PRODUCT UNIQUENESS

Ubreez is the first shareable air quality monitoring device, which means that the data from one Ubox can be shared among as many users, as needed. This way, you can track the air quality in your home, workplace and your kids' school. You can know when temperature, humidity, pressure, level of CO2 or volatile chemicals (TVOC) start causing discomfort. If any reading is outside of the optimal range, the Ubreez Box sends a notification to your UBreez app. Monitor air components everywhere – track what's in the air and always know its quality. Receive instant alerts when the quality is not optimal – know ahead and be proactive. Improve the productivity of your work and learning – poor air affects your wellness. Reduce energy losses and bills – ventilate the room or purify air only when necessary. Save time and money – prevent air-related health issues.

click on the icon



## MORE DETAILS



Website



Facebook



Instagram

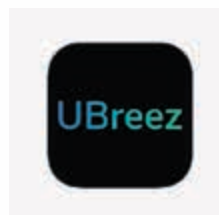

CEO, Mr. Vova Shevchyk  
E-mail: [hello@ubreez.com](mailto:hello@ubreez.com)  
Tel.: +380930229123

# UGEARS: UNIQUE SELF-PROPELLED MECHANICAL MODELS

"As people say, men are big kids, only their toys are more expensive. For us, our models are not just toys. It's the exclusive models that can appear in the homes of those who assembled them with their own hands".

## MAIN INDUSTRIES

Design, Toys, Mechanical Models.

## PRODUCT UNIQUENESS

In its models, UGEARS employs many innovations that haven't been used in prototypes. Such as an extraordinary connection method that has been recognized as a unique invention and internationally licensed. The mechanisms hidden inside the devices we use in our lives are made so tiny these days that people became deprived of a possibility to behold of the magic of moving gears. Our attractive models are made of a high-quality plywood tested in the European laboratories and also approved for use in the production of furniture for children. In the process of assembly, there is an important moment of "birth" – when the model shows the first spark of life. There is a real magic in the rotation of the gears.

click on the icon



**VIDEO  
PRESENTATION**

## MORE DETAILS



Website



Facebook



Instagram



Twitter

## PRODUCT IN THE MEDIA

Königliche  
Hochzeitskutsche

UGEARS: elaborate  
self-propelled DIY  
Mechanical Models

UGEARS: Ukrainian  
wooden toys that  
conquered the world



CEO, Mr. Gennady Shestak  
E-mail: myugears@ugearsmodels.com



UGEARS

# VIRTUAL REALITY FOR THERAPY, TRAININGS AND EDUCATION

"We created a platform that hosts individual stress relief VR product then released a new solution for VR business trainings, now we are ready to expand into the VR training sector of the market, which is just emerging".

## MAIN INDUSTRIES

Health, Education, Wellness.

## PRODUCT UNIQUENESS

VOXBOX is a platform for VR experiences, which immerse the user in various psychological states. In the Scream Stress therapy app, we measure a person's voice, his cry with a visual space that changes depending on 32 parameters of the voice. In the training product STRAH-OFF for corporations, we have created 360-degree video with a multivariate scenario in which the user makes choices himself and eventually realizes the consequences of his reactions. All this takes place in the atmosphere of time pressure and complete immersion into the situation.

click on the icon



**VIDEO PRESENTATION**

## MORE DETAILS



Website



Facebook

## PRODUCT IN THE MEDIA

Крики: українці винайшли оригінальний спосіб боротьби зі стресом

VoxBox team offers virtual reality scream therapy for stress



CEO, Mr. Yaroslav Ploshko  
E-mail: info@voxbox.tech,  
yaroslav@cmsgroup.holdings  
Tel.: +380952701414  
+19549039319



# WHOOSHI BLUETOOTH 5.0 HI-FI HEADPHONES AMPLIFIER

"Ears are unique to each listener. We all hear sounds differently. If the lenses on your glasses are tailored to your personal vision, why not apply the same approach to sound? It's like a pair of glasses for your ears".

## MAIN INDUSTRIES

SoundTailoring (W-Tailoring), SoundHeart (W-Heart), SoundFeeling (W-Feeling) Technologies.

## PRODUCT UNIQUENESS

Perfect headphones do not exist. All devices have their own sound transmission characteristics and distort the frequency of the sound you hear in one way or another. Whooshi strives to ensure the maximum accuracy of sound transmission on all audio devices. The device transforms any pair of headphones into a wireless device. The Whooshi app for iOS and Android creates personal audio profiles for listeners and adapts the sound to their individual hearing characteristics.

click on the icon



**VIDEO  
PRESENTATION**

## MORE DETAILS



Website



Facebook



Instagram

## PRODUCT IN THE MEDIA

WHOOSHI Bluetooth headphone amplifier



CEO, Mr. Denys Popov  
E-mail: [info@whooshi.me](mailto:info@whooshi.me)  
Tel.: +380939013879



Whooshi

# XBEAM 3D METAL PRINTING - A REVOLUTIONARY INDUSTRIAL METAL 3D PRINTERS

"xBeam 3D Metal Printing - the advanced Additive Manufacturing technology which was invented to make the metal 3D printing a truly widespread manufacturing solution".

## MAIN INDUSTRIES

Aerospace, Machinery, Oil&Gas, Shipbuilding, R&D.

## PRODUCT UNIQUENESS

Unique electron beam gun, which is the key element of the xBeam 3D technology and equipment, provides the possibility to produce complex parts of many metals including titanium, niobium, stainless and carbon steel with high productivity and fair accuracy, resulting in the dramatic reduction of the operating cost and material losses. Perhaps, it is the first technology in the Additive Manufacturing industry which nearly perfectly fits the Lean Manufacturing concept – minimum waste and maximum effectiveness. xBeam 3D Metal Printing allows producing high-quality metal components from the simple metal wire, available at the nearest welding shop, on the equipment which can be easily integrated into existing manufacturing workshop or even into the R&D laboratory. Furthermore, it opens numerous opportunities for the development of new designs and new materials with the new properties.



click on the icon



**VIDEO  
PRESENTATION**

## MORE DETAILS



Website



Facebook



Linkedin



Twitter

## PRODUCT IN THE MEDIA

«Зелений» титан – як українці з «Червоної хвилі» впроваджують cleantech в металургії

Chervona hvilya showcases xBeam Metal 3D Printing System at RAPID + TCT, Partners with TWI



CEO, Mr. Dmytro Kovalchuk

E-mail: [info@xbeam3d.com](mailto:info@xbeam3d.com)

Tel.: +380503118393



**SMART  
UKRAINE**  
**Connecting  
dots**



Implemented by:  
**giz** Deutsche Gesellschaft  
für Internationale  
Zusammenarbeit (GIZ) GmbH



Information in this brochure collected by the Ministry of Economic Development, Trade and Agriculture of Ukraine in preparation for the Innovation Month in the United Arab Emirates.